

# PT-Actuator

## Champion GT Setup Guide

3dof motion system for sim racing

Please use the guidance below to setup your PT-Actuator / Thanos motion platform to work with Sim Racing Studio. The guide will cover the following topics:

- Thanos AMC Controller Firmware Update
- Installing/Updating the FTDI (VCP) Driver
- Thanos AMC 4in1 Controller Setup
- Champion GT Hardware Setup
- Sim Racing Studio Installation
- Champion GT Configuration
- Champion GT Test
- Game Setup
- Using the Champion GT with a Game
- Champion GT Motion Tuning

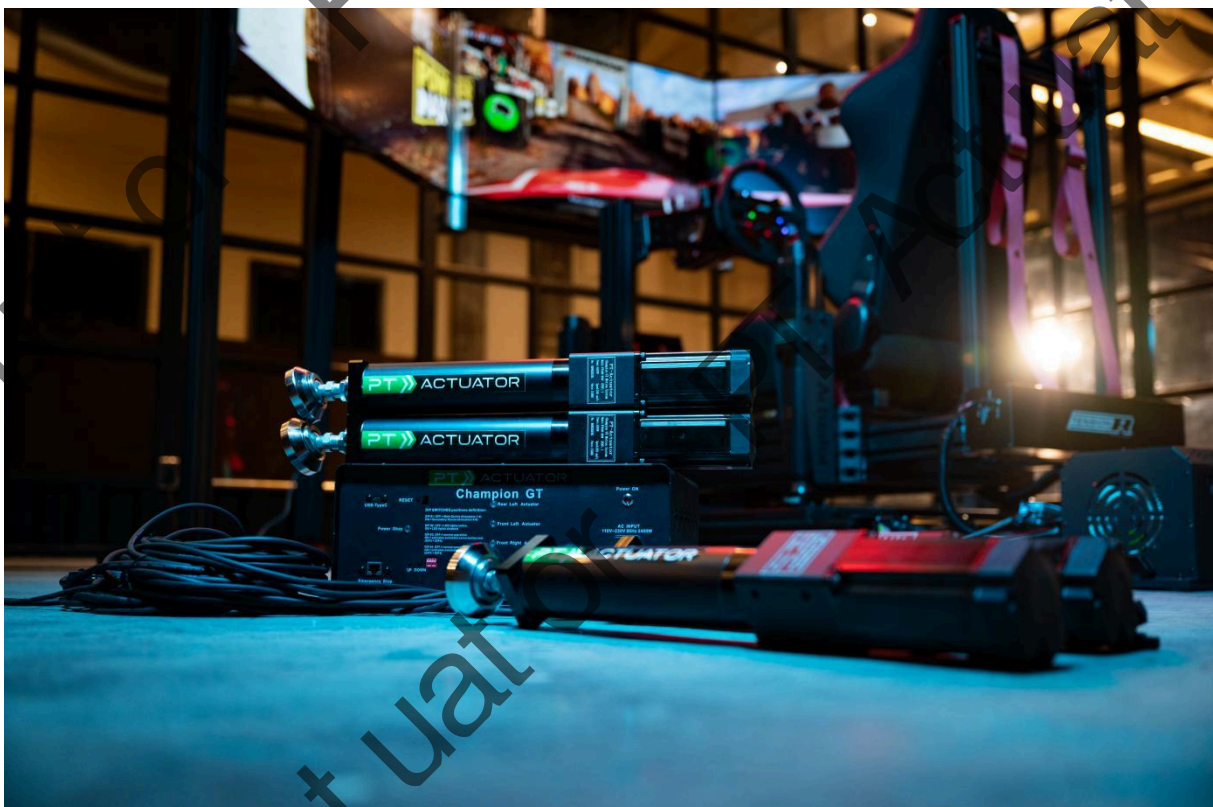

## Thanos AMC Controller Firmware Update

Prior to setting up Sim Racing Studio with your PT-Actuator / Thanos platform, make sure you have the latest version of firmware installed on your Thanos AMC Controller. Follow the guide [here](#) on how to update your Thanos firmware. You can find the Thanos firmware [here](#) as well.

## Installing/Updating the FTDI (VCP) Driver

The USB data connection for your Thanos controller requires an FTDI driver. The device will then appear in the Windows Device Manager as USB Serial Port (COMXX) which will allow Sim Racing Studio to communicate with the Thanos controller.

To install/update the FTDI (VCP) Driver, follow the steps below:

1. Go to <https://ftdichip.com/drivers/vcp-drivers/>
2. Select the correct file for your Operating System. For Windows 10 64-bit, it would be the one highlighted below. Note: It may update in the future.

### VCP Drivers

Virtual COM port (VCP) drivers cause the USB device to appear as an additional COM port available to the PC. Application software can access the USB device in the same way as it would access a standard COM port.

This software is provided by Future Technology Devices International Limited "as is" and any express or implied warranties, including, but not limited to, the implied warranties of merchantability and fitness for a particular purpose are disclaimed. In no event shall future technology devices international limited be liable for any direct, indirect, incidental, special, exemplary, or consequential damages (including, but not limited to, procurement of substitute goods or services; loss of use, data, or profits; or business interruption) however caused and on any theory of liability, whether in contract, strict liability, or tort (including negligence or otherwise) arising in any way out of the use of this software, even if advised of the possibility of such damage.

FTDI drivers may be used only in conjunction with products based on FTDI parts.

FTDI drivers may be distributed in any form as long as license information is not modified.

If a custom vendor ID and/or product ID or description string are used, it is the responsibility of the product manufacturer to maintain any changes and subsequent WHCK re-certification as a result of making these changes.

For more detail on FTDI Chip Driver licence terms, please [click here](#).

Currently Supported VCP Drivers:

[Subscribe to Our Driver Updates](#)

Operating System	Release Date	Processor Architecture						
		X86 (32-bit)	X64 (64-bit)	PPC	ARM	MIPSII	MIPSIV	SH4
Windows (Desktop)*	2021-07-15	<a href="#">2.12.36.4</a>	<a href="#">2.12.36.4</a>	-	<a href="#">2.12.36.4A****</a>	-	-	-
Windows (Universal)***	2021-11-12	<a href="#">2.12.36.4U</a>	<a href="#">2.12.36.4U</a>	-	-	-	-	-
Linux	-	-	-	-	-	-	-	-
Mac OS X 10.3 to 10.8	2012-08-10	<a href="#">2.2.18</a>	<a href="#">2.2.18</a>	<a href="#">2.2.18</a>	-	-	-	-
Mac OS X 10.9 to 10.13	2019-12-24	-	<a href="#">2.4.2</a>	-	-	-	-	-

3. Download the file

4. Extract the file by double clicking on it and moving the files to a new folder on your computer. Be sure to remember where you extract the files.

5. Go to Device Manager and select the COM port that is used for the Thanos controller. It can be any COM port, but it usually appears as 'USB Serial Port (COM8):



6. Browse your computer for the folder you extracted the driver files and choose the root folder (you don't need to select the sub-folders)
7. Right click on the USB Serial Port (COM8) and select 'Update driver'



8. When the window opens, select the second option to 'Browse my computer for drivers'
9. Click Next
10. Your FTDI (VCP) driver is now updated

### Thanos AMC Controller Setup

Configure the Thanos AMC Controller as directed by the Thanos AMC Controller Manual or guidance provided by PT-Actuator. (All preset)

### PT-Actuator / Thanos Hardware Setup

Ensure each actuator is connected to the appropriate port on the Thanos AMC Controller as per the image below:



1. Champion GT 3dof motion system supporting the AC input 110V to 230V 50/60hz worldwide without adding extra power transformer.
2. Plug the power socket into the outlet and switch the button to "ON" position.
3. Plug USB-Type C cable to your PC motherboard USB port( USB2.0/USB3.0)
4. Plug the emergency stop button for your safety, standard LAN wiring cable( package included)
5. Before SRS installation, press UP/DOWN button to check whether the 4 actuators are working perfectly/smooth up and down as your finger command. (if all worked fine, congratulations! All wiring are correct,and go to SRS for app installation)→



## Sim Racing Studio Installation

1. Close all other motion software before installing Sim Racing Studio.
2. Download and install Sim Racing Studio (<https://www.simracingstudio.com/download>)
3. Once Sim Racing Studio is installed, follow the guidance here to activate your license.  
(Please contact your dealer to ask the valid license to activate the SimRacingStudio)

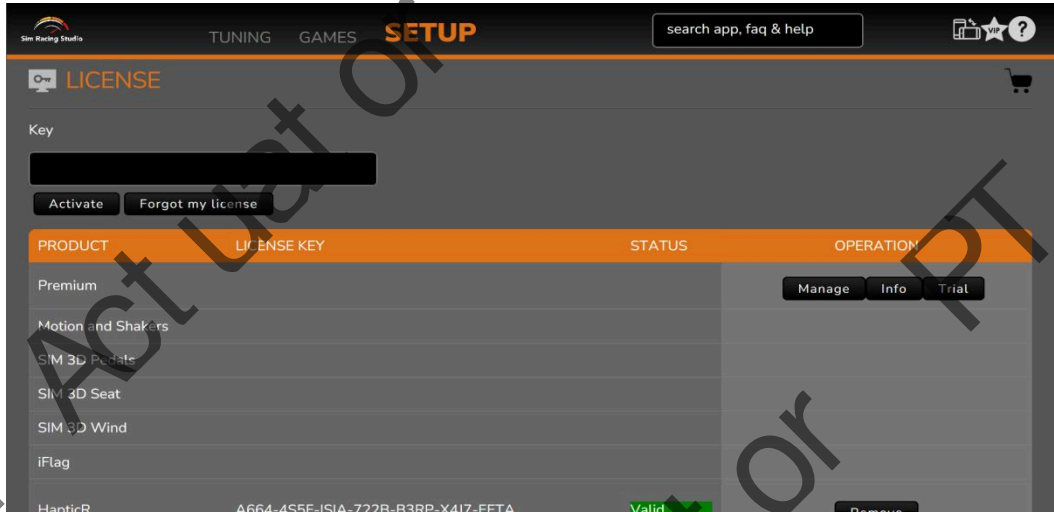

## Hardware Configuration

1. Once your license has been activated, click SETUP at the top and select Hardware in the left toolbar
2. Scroll down to the MOTION section
3. Ensure that the Enabled button is set to On
4. In the Manufacturer field, select PT-Actuator or Thanos

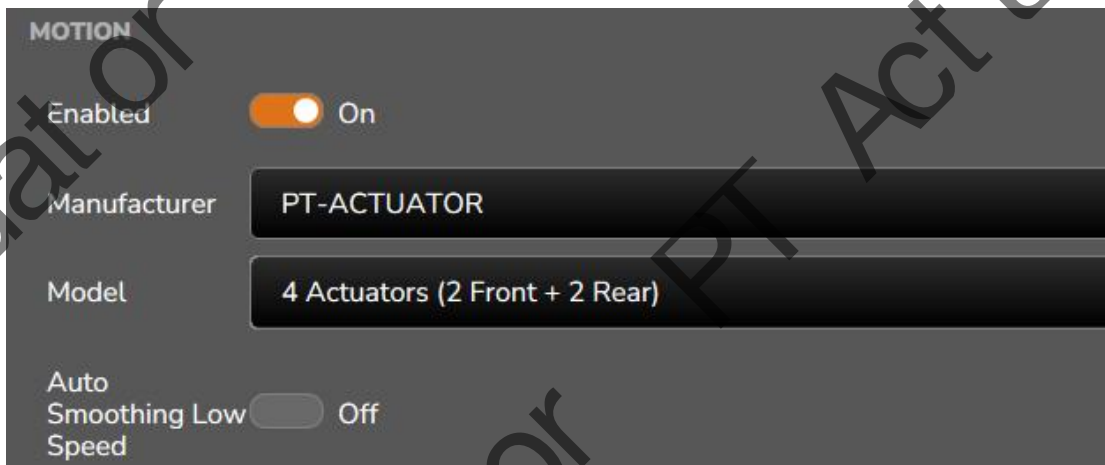

# PT ACTUATOR

In the Model field, select the option that represent the number and placement of actuators for your platform

1. Click SAVE in the upper right in the PROFILE IN USE box
2. Wait up to 30 seconds for a green check mark to appear next to Motionbox in the HARDWARE STATUS box in the right toolbar for Sim Racing Studio to detect the Thanos AMC Controller.

## Hardware Test

Once you have completed the Hardware Configuration steps, test the platform's movement. On the SETUP > Hardware page in the Motion section, click on the Start Test button and move the sliders from left to right. Verify that the PT-Actuator / Thanos platform is moving correctly. If its not moving correctly, check that you have the actuator cables properly connected in

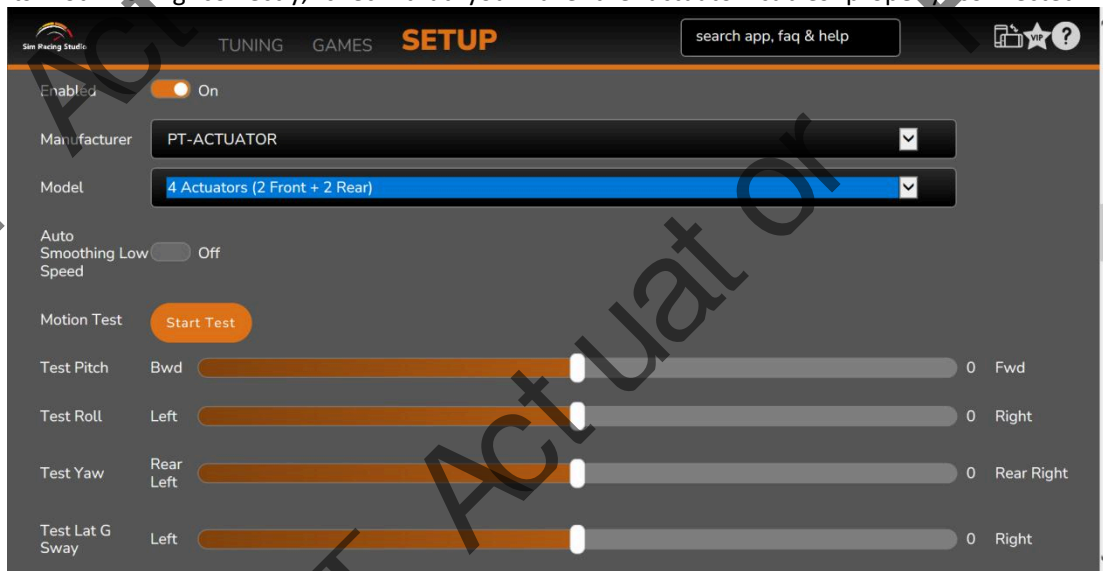

Hardware Configuration in Step

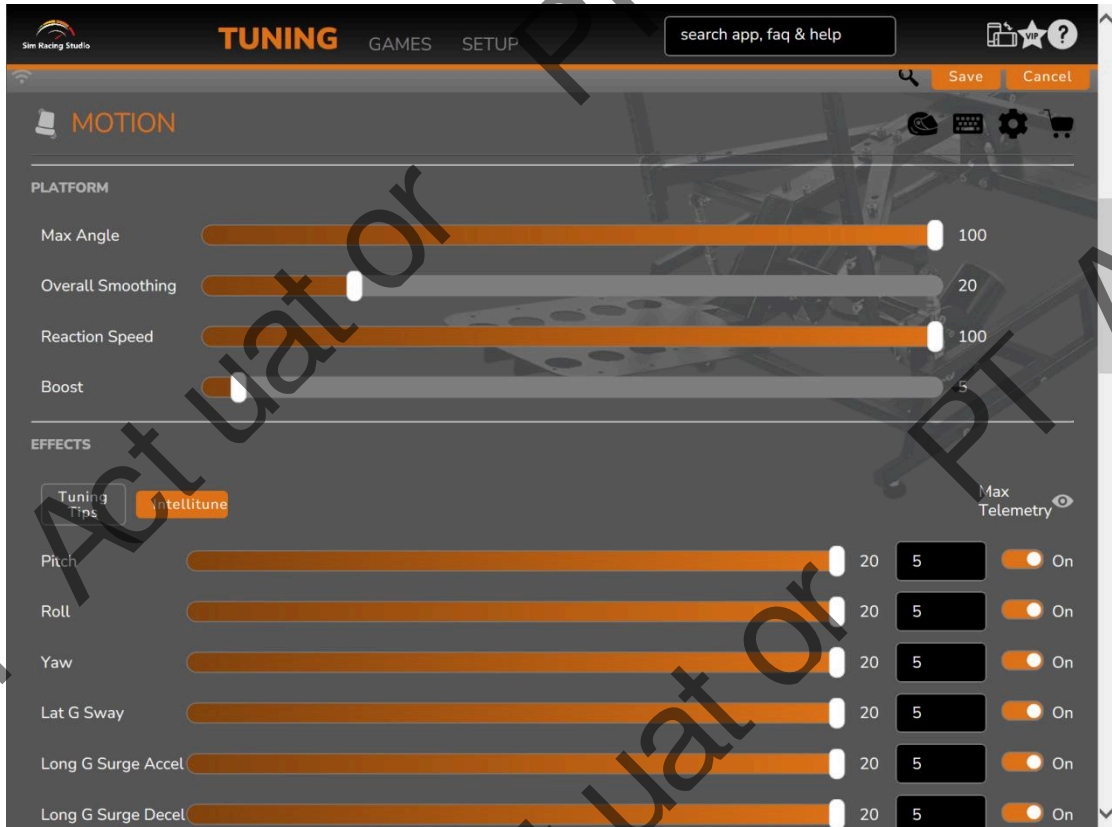

## PT-Actuator / Thanos Motion Tuning

To make basic adjustments to motion, use the Quick Motion Tuning guide here.

For detailed information on motion tuning, use the Motion Tuning Guide found here.



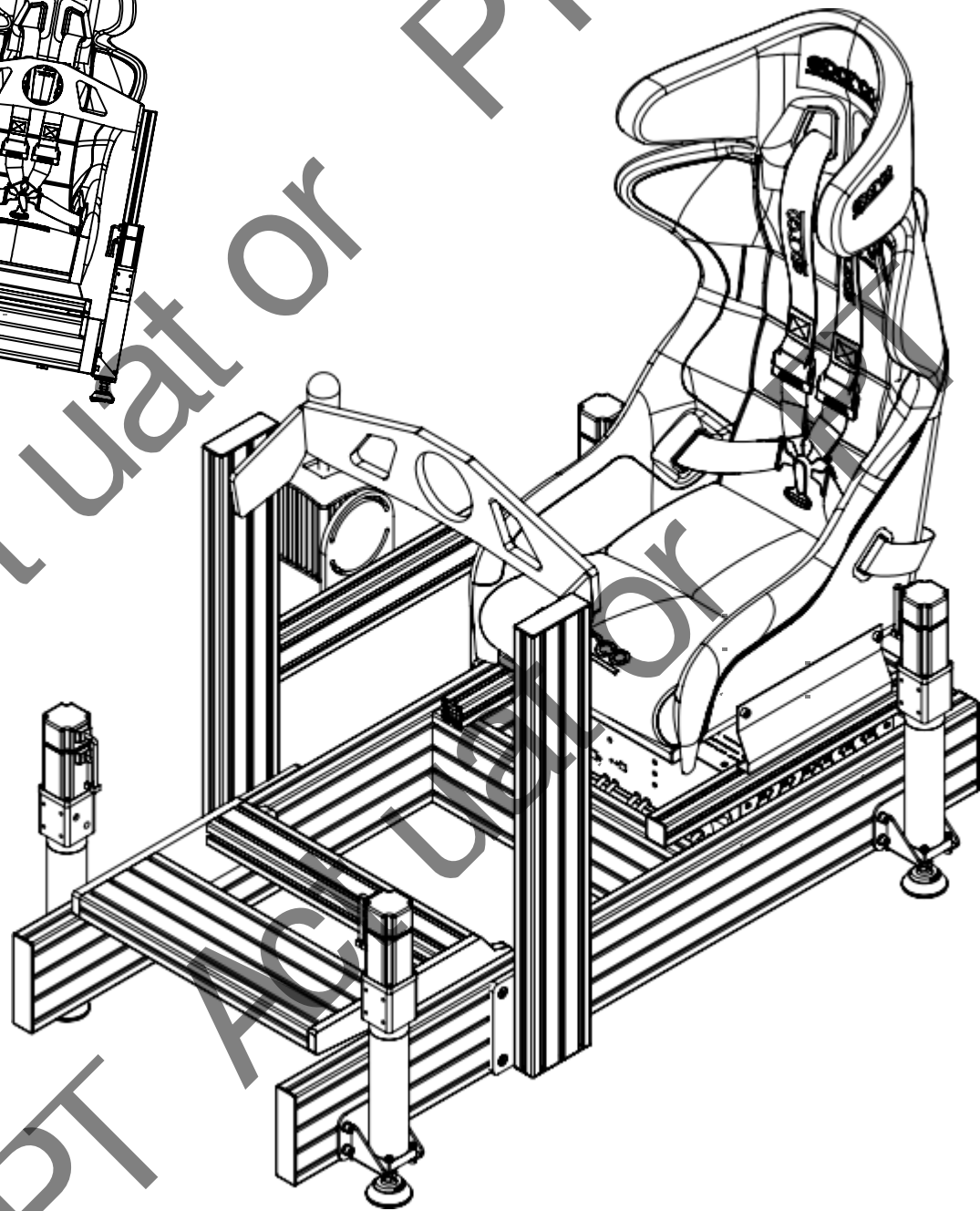
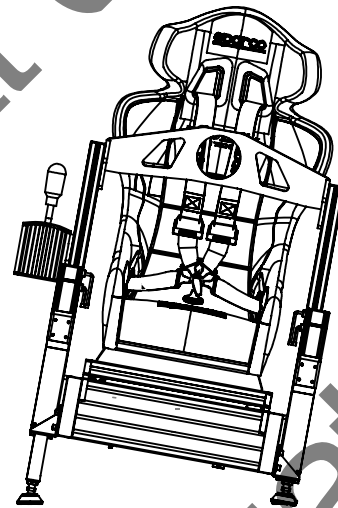
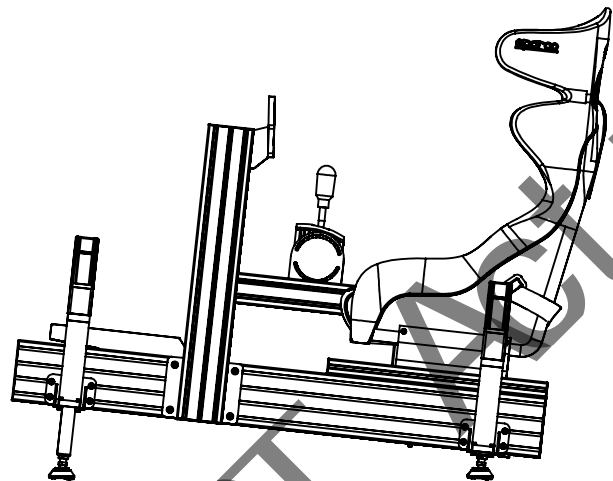

## Specification.

Heave (disp/vel/accel.) 0-125 mm, 250 mm/s

Pitch (disp/vel/accel.)  $\pm 7^\circ$ ,  $\pm 20^\circ/\text{s}$ ,  $210^\circ/\text{s}^2$

Roll (disp/vel/accel.)  $\pm 15^\circ$ ,  $\pm 35^\circ/\text{s}$ ,  $280^\circ/\text{s}^2$

Payload max 300 Kg (110-255VAC)(90-150VAC)

Champion GT System Weight 34 kg / 75 lbs

# PT ACTUATOR

